

Intelligent Hybrid System

XN120 Vision and XN120 Talk Telephone User Guide

**In the European Union**

The symbol depicted here has been affixed to your product in order to inform you that electrical and electronic products should never be disposed of as municipal waste.

Electrical and electronic products including the cables, plugs and accessories should be disposed of separately in order to allow proper treatment, recovery and recycling. These products should be taken to a designated facility where the best available treatment, recovery and recycling techniques are available. Separate disposal has significant advantages: valuable materials can be re-used and it prevents the dispersion of unwanted substances into the municipal waste stream. This contributes to the protection of human health and the environment.

Please be informed that a fine may be imposed for illegal disposal of electrical and electronic products via the general municipal waste stream.

In order to facilitate separate disposal and environmentally sound recycling, NEC Infrontia has made arrangements for local recycling in all member states of the European Union. In case your electrical and electronic products need to be disposed of please refer to the contractual agreements that your company has made upon acquisition of these products. Should this information not be available, please contact us at recycle@necinfrontia.co.uk.

For countries outside the European Union

Disposal of electrical and electronic products in countries outside the European Union should be done in line with local regulations. If no arrangement has been made with NEC Infrontia or your supplier, please contact the local authorities for further information.

Before using Your Telephone...

Thank you for purchasing the NEC XN120 system.

Due to the flexibility built into the system, your **Dialling Codes and Feature Capacities** may differ from those in this guide. Check with your Supplier / System Administrator and make a note of any differences.

Using Your Multiline Telephone...

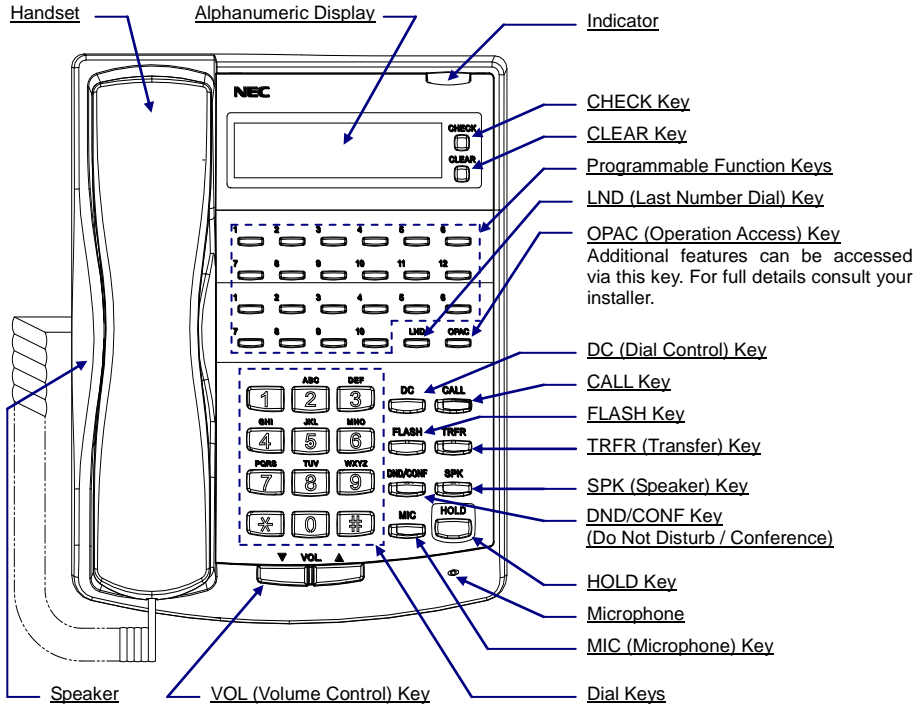

Functions	XN120 Vision	XN120 Talk
Programmable Keys	12	12
Additional Prg. Keys	10	10
Display	Yes	No
CHECK/CLEAR Keys	Yes	No
Handsfree	Yes	No (Talkback)
Accept DLS Console	Yes	No
Wall Mount Kit	Yes (Built-in)	Yes (Built-in)

Handsfree Options

- Handsfree lets you place and answer calls by pressing "SPK" instead of using the handset.
- With Automatic Handsfree, you can press the CALL Key without lifting the handset. Normally, you have Automatic Handsfree.
- Use Handsfree Answerback to answer a voice-announced Intercom call by speaking toward your phone without lifting the handset.

For Your Convenience

Programming a Function Key

Programmable Function Keys can be assigned as Appearance Keys (e.g. Trunks) or General Keys (e.g. DSS/One-Touch). Press the Function Key to activate the assigned function without dialling the Service Code.

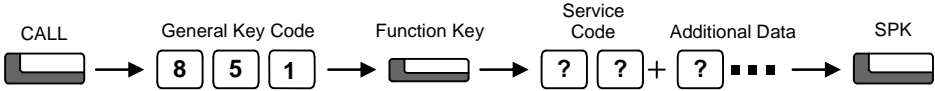

- ◆ An existing Appearance Key cannot be overwritten without the Appearance Key first being erased.
- ◆ Programmable Function Keys (General Key Code) can be erased by entering Service Code 00.

Common Service Codes:

01	DSS/One-Touch Key	10	Call Forward – Immediate
03	DND Key	11	Call Forward – Busy
04	Background Music (ON/OFF)	12	Call Forward – No Answer
05	Headset Key	13	Call Forward – Busy/No Answer
08	Incoming Caller ID List	14	Call Forward – Dual Ring
19	External Zone Paging	15	Call Forward – Follow Me
20	External All Call Paging	16	Call Forward – Select Option
21	Internal Zone Paging	17	Call Forward – Device
22	Internal All Call Paging	29	Repeat Redial
27	Abbreviated Dial – Common/Personal	30	Saved Number Redial
28	Abbreviated Dial – Group	31	Memo Dial
85	Directory Dialling		

Programming a DSS/One-Touch Key

Programmable Function Keys can be assigned as DSS (Direct Station Selection) or One-Touch Keys. You can place an Outside or Intercom call by pressing this key without dialling the number.

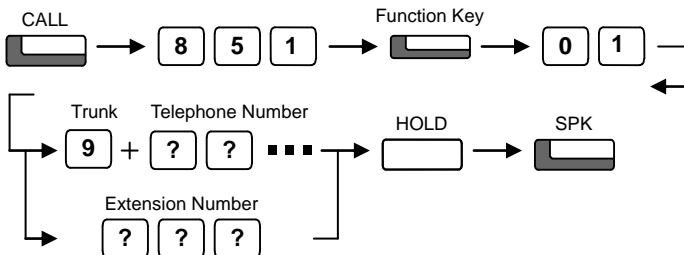

- ◆ Function Keys with one or two colour LEDs programmed as DSS keys will provide extension status indication, Idle=Off, Busy=lit. This is known as Busy Lamp Field (BLF) indication.
- ◆ When storing an outside telephone number, the Trunk Access Code (normally 9) must be added to the start of the number. Up to 36 digits can be stored.
- ◆ To program another key, press the next Programmable Function Key instead of the SPK Key to finish.

For Your Convenience

Programming Abbreviated Dialling Bins

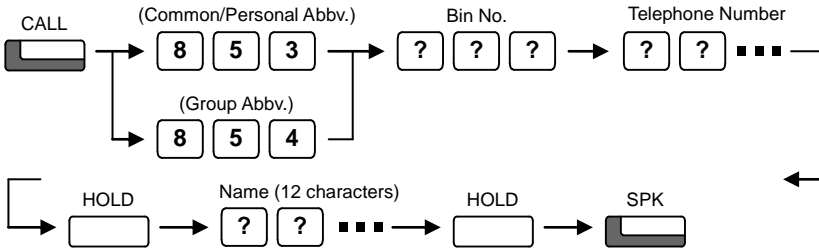

- ◆ Common/Personal Abbreviated Dialling Bins are numbered as follows (by default):
 2-digit dialling: Common = 00-79, Personal = 80-99, or
 3-digit dialling: Common = 000-899, Personal = 990-919.
- ◆ System programming is required to allow Group Abbreviated Dialling. Ask your NEC Authorised Supplier.
- ◆ Up to 36 digits dialling can be stored in each abbreviated dialling bin.
- ◆ To clear an abbreviated dialling bin (number & name), press the "CLEAR" key after dialling the Bin No.
- ◆ Applicable to XN120 Vision Phones only.

Entering a Name into an Abbreviated Dialling Bin

When entering a name, use the Dial Pad Keys on your telephone to enter letters as shown below. For example, press the "2" key once for "A", twice for "B", etc...

	Number of Key Presses												
	1	2	3	4	5	6	7	8	9	10	11	12	13
1	1	@	[¥]	^	_	'	{		}	→	←
2	A	B	C	a	b	c	2						
3	D	E	F	d	e	f	3						
4	G	H	I	g	h	i	4						
5	J	K	L	j	k	l	5						
6	M	N	O	m	n	o	6						
7	P	Q	R	S	p	q	r	s	7				
8	T	U	V	t	u	v	8						
9	W	X	Y	Z	w	x	y	z	9				
0	0	!	"	#	\$	%	&	'	()			
*	*	+	,	-	.	/	:	;	<	=	>	?	

Accepts a character and move the cursor one place to the right. Press twice to insert a "space".

DND/CONF Clear the character entry to the left, one character at a time (Backspace Key).

Placing Calls

Placing an Outside Call <Quick Access>

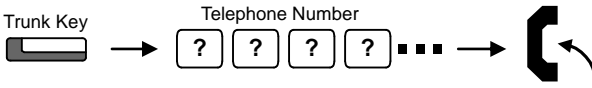

- ◆ Listen for Dial Tone before dialling a Telephone Number.
- ◆ You can have function keys for Trunks or Trunk Groups. Ask your Supplier.

Placing an Outside Call <Access Code>

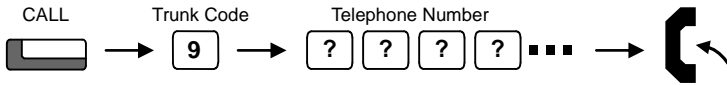

- ◆ Listen for Dial Tone before dialling the Telephone Number.

Placing an Intercom Call <Dial Access>

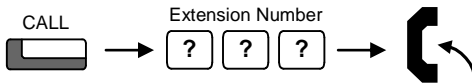

- ◆ Pressing CALL key after dialling an extension number is also possible.
- ◆ Your call will ring or voice-announce. If you hear ringing, wait for an answer. If you hear a beep, begin speaking. Dialling "1" changes voice/ring mode (where the destination is an XN120 Telephone).

Placing Calls Quickly

Using Abbreviated Dialling <Outside Calls>

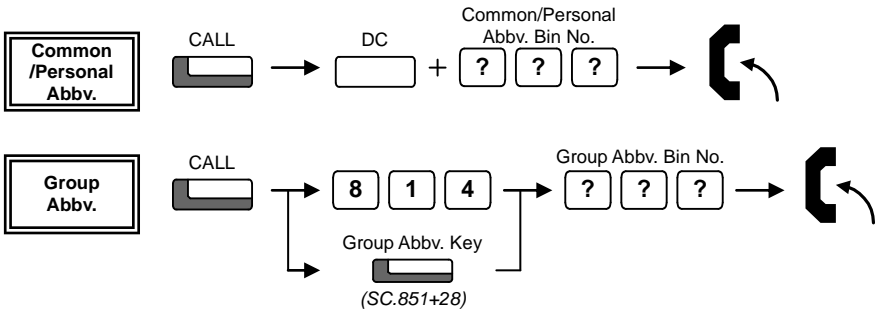

- ◆ Common/Personal Abbreviated Dialling Bins are numbered as follows (by default):
2-digit dialling: Common = 00-79, Personal = 80-99, or
3-digit dialling: Common = 000-899, Personal = 900-919.
- ◆ System programming is required to provide Group Abbreviated Dialling. Ask your NEC Authorised Supplier for details.

Using One-Touch Keys <Outside/Intercom Calls>

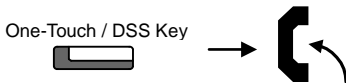

- ◆ The Telephone / Extension Number shall be pre-registered to a One-Touch / DSS Key (refer to Page 2).
- ◆ Trunk Access Code (Dial "0") should be added as the first digit of the Telephone Number.

Last Number Redial < Outside/Intercom Calls>

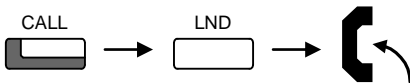

Redial List

The system retains the last 10 numbers dialled which can be viewed and dialled.
(XN120 Vision Phones Only)

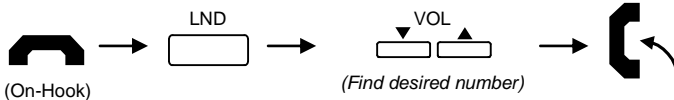

- ◆ Intercom numbers can also be stored under Last Number Redial. Ask your NEC Authorised Supplier for details.

If your call doesn't go through...

Setting Camp On / Callback / Trunk Queuing

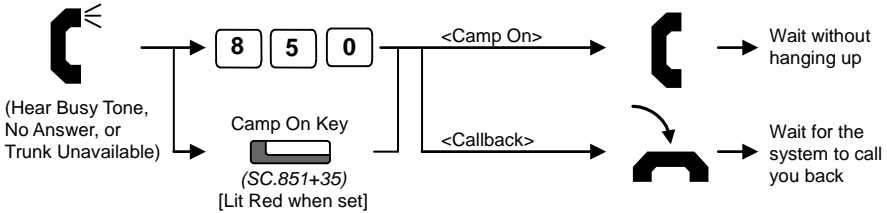

- ◆ **<Camp On>** For Intercom Call, when you hear ringing, wait for the called party to answer.
For Trunk Queuing, when you hear Dial Tone, begin dialling the telephone number.
- ◆ **<Callback>** For Intercom Call, when your phone starts the ringing, lift handset and wait for the called party to answer.
For Trunk Queuing, when your phone starts the ringing, lift handset, hear Dial Tone and begin dialling the telephone number.

Cancelling Camp On / Callback / Trunk Queuing

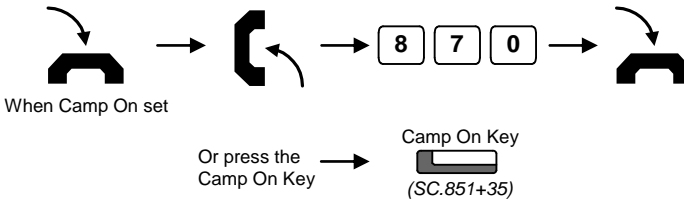

Set / Answer a Message Waiting

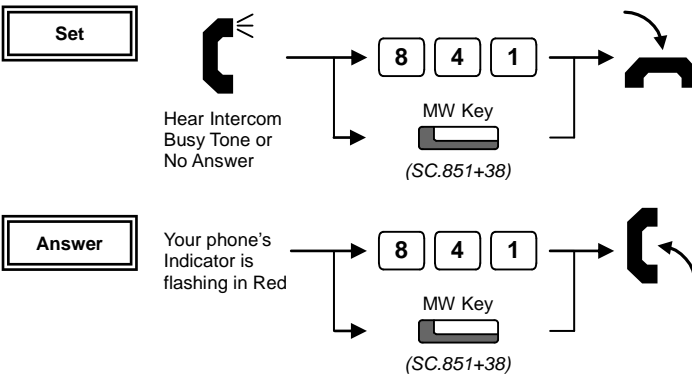

- ◆ When you set a MW, the called party's MW Indicator starts to flash, and your MW Indicator is lit Red.
- ◆ When you answer a MW, the MW Indicator will automatically go off when the called party answers.

If your call doesn't go through...

Checking & Answering a Message Waiting Indication

You can check who left a message waiting indication for you, and then answer.

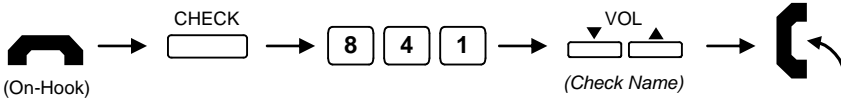

◆ *Applicable to XN120 Vision Telephones only.*

Cancelling a Message Waiting Indication (at originating extension)

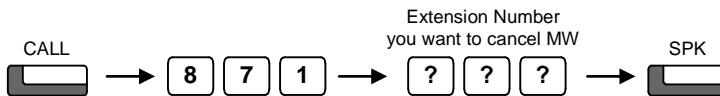

Clearing All Message Waiting Indications (at any extension)

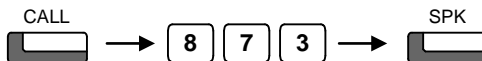

◆ *Clears all messages you have left for other extensions and messages other extension have left for you.*

Repeat Dialling <Outside Call>

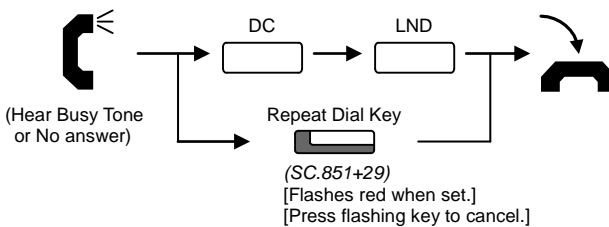

- ◆ *The system periodically redials the call. Repeat duration is programmable. Ask your NEC Authorised Supplier for details.*
- ◆ *You should lift the handset when the called party answered.*
- ◆ *You can cancel this function by pressing "DC" and "LND" during idle condition.*
- ◆ *Does not reserve line. Will select other available line when original line is in use.*

Answering Calls

Answering an Outside Call

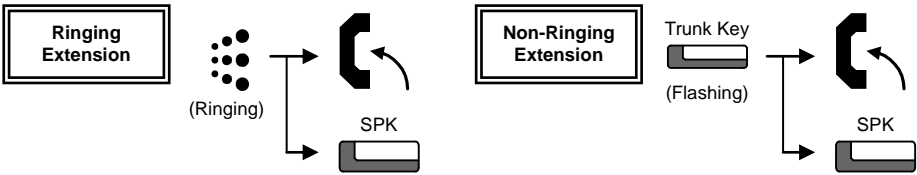

- ◆ Confirm status of the MIC Key if you want to answer Handsfree [MIC On = Light On, MIC Off = Light Off]. (XN120 Vision Phones Only)

Answering an Intercom Call

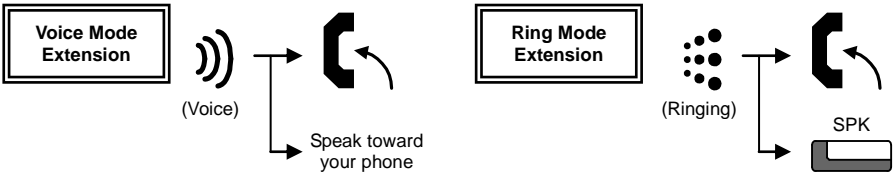

- ◆ Intercom Call Mode can be set at your phone as follows: "Ring" = CALL + 823, "Voice" = CALL + 821.
- ◆ Confirm status of the MIC Key if you want to answer Handsfree [MIC On = Light On, MIC Off = Light Off]

Picking up another Extension's Call

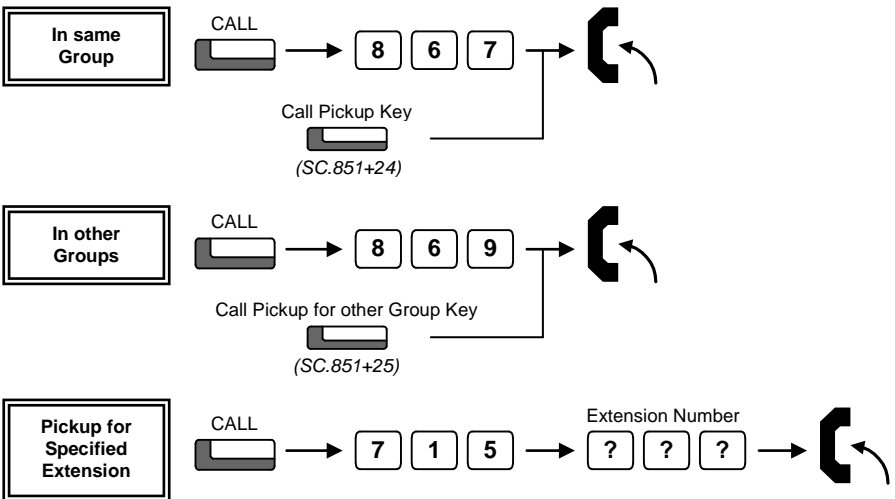

- ◆ System programming is required to allow Group Call Pickup. Ask your NEC Authorised Supplier for details

Hold / Transferring Calls

Placing a Call on Hold / Retrieving a Held Call

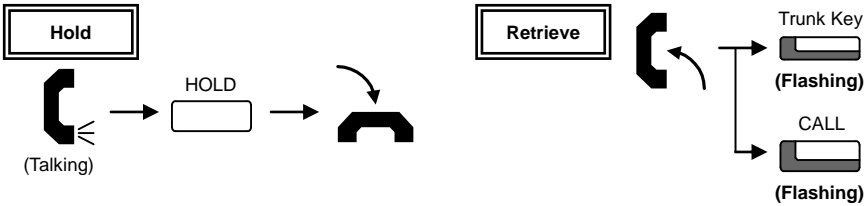

- ◆ When an Intercom call is placed on hold, the call is held as “Exclusive Hold” on your phone.
- ◆ While your outside call is on System Hold, other extension users can take the call off Hold.

Placing a Call on Exclusive Hold

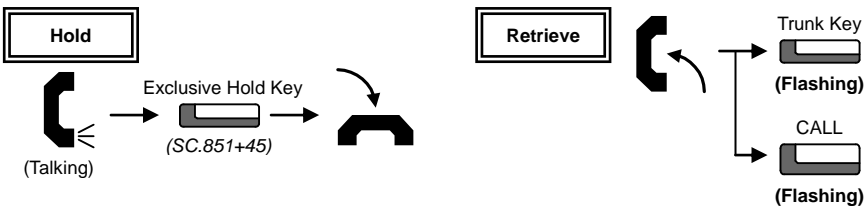

- ◆ System programming is required to use Exclusive Hold. Ask your NEC Authorised Supplier for details.
- ◆ While your outside call is on Exclusive Hold, other extension users can not take the call off Hold.

Retrieving a Held Outside Call (if your extension doesn't have trunk keys)

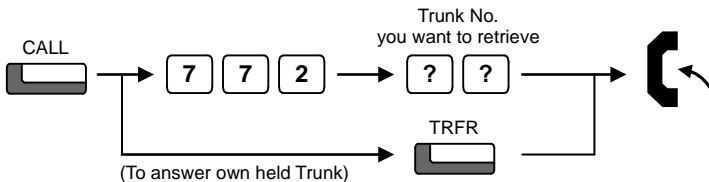

Transferring a Call to another Extension

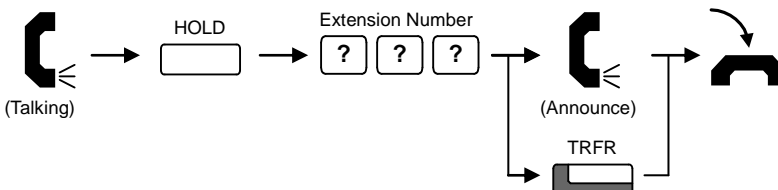

- ◆ If your phone has a DSS or One-Touch key for the extension user who is to receive the call, just press it instead of “HOLD + Extension Number” in the operation above.

For more convenient use...

Do Not Disturb (DND)

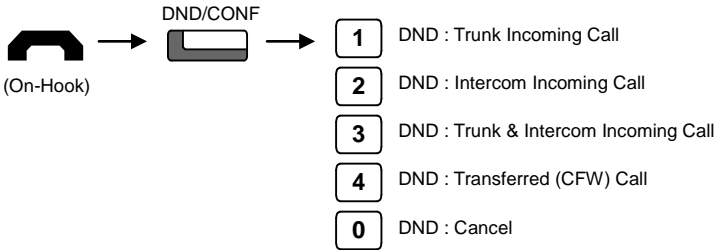

◆ When you set DND, the DND/CONF Key's lamp is lit and the Internal Dial Tone pattern changes.

Call Forward / Follow Me

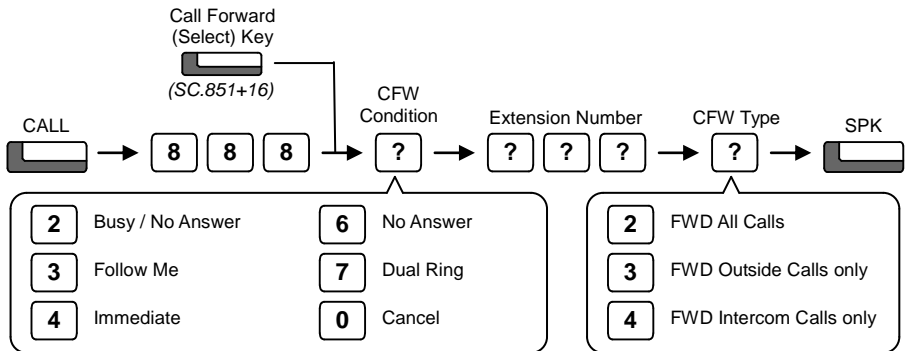

◆ When you set a Call Forward, the DND/CONF Key's lamp flashes and Internal Dial Tone pattern changes.

◆ When using a Call Forward (Select) Key, press the key and wait to cancel a Call Forward setting, then press the key and wait again to restore the previous Call Forward setting.

Call Forward Off-Premise

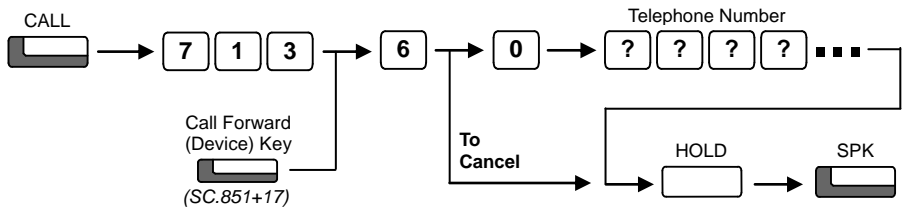

◆ When you set a Call Forward, the DND/CONF Key's lamp flashes and the Internal Dial Tone pattern changes.

Hard of Hearing Options

Volume Controls

You can increase the volume of the **ringing** by pressing the VOL.▲ button while your phone is ringing or when the phone is idle by pressing SPK and dialling 829.

Ensure your phone is set to RING mode. See Answering an Intercom Call in this guide.

You can increase the volume of the **handset earpiece** by pressing the VOL.▲ button when the handset is off hook.

There are three volume settings (Low - Med - High).

Visual indications

The **indicator lamp** at the top corner of the XN120 Vision and Talk phone will flash RED to indicate various call types:

- **Intercom Call.** Your phone is ringing, the CALL key is flashing red and the display will show FROM and the callers name/number.
- **Outside Call.** Your phone is ringing, the display may show the callers name/number or RINGING.
- **Message Waiting.** See *Message Waiting in this guide.*
- **You may have a new Voice Mail Message.** See *the separate Voice Mail and Voice Response System User Guide.*

The **LCD display** of the XN120 Vision phone will show the callers name and number for internal calls and also where available for outside calls.

Hearing Aid Compatibility

The earpiece within the handset of the XN120 Vision and Talk handset has a built in inductive coupler and is compatible with hearing aids that have the 'T' setting.

Additional Options

The ringing tone/pitch can not be changed on the XN120 Vision or Talk phones.

Consult the system supplier/installer for additional volume settings or equipment that may help.



In the European Union

The symbol depicted here has been affixed to your product in order to inform you that electrical and electronic products should never be disposed of as municipal waste.

Electrical and electronic products including the cables, plugs and accessories should be disposed of separately in order to allow proper treatment, recovery and recycling. These products should be taken to a designated facility where the best available treatment, recovery and recycling techniques are available. Separate disposal has significant advantages: valuable materials can be re-used and it prevents the dispersion of unwanted substances into the municipal waste stream. This contributes to the protection of human health and the environment.

Please be informed that a fine may be imposed for illegal disposal of electrical and electronic products via the general municipal waste stream.

In order to facilitate separate disposal and environmentally sound recycling, NEC Infrontia has made arrangements for local recycling in all member states of the European Union. In case your electrical and electronic products need to be disposed of please refer to the contractual agreements that your company has made upon acquisition of these products. Should this information not be available, please contact us at recycle@necinfrontia.co.uk.

For countries outside the European Union

Disposal of electrical and electronic products in countries outside the European Union should be done in line with local regulations. If no arrangement has been made with NEC Infrontia or your supplier, please contact the local authorities for further information.

Regulatory Notice. Refer to the Getting Started Guide (991409-5) supplied with the XN120 Main Unit for the Declaration of Conformity related to the product.

Nothing contained in this manual shall be deemed to be, and this manual does not constitute, a warranty of, or representation with respect to, any of the equipment covered. This manual is subject to change without notice and NEC Infrontia Ltd has no obligation to provide any updates or corrections to this manual. Further, NEC Infrontia Ltd also reserves the right, without prior notice, to make changes in equipment design or components as it deems appropriate. No representation is made that this manual is complete or accurate in all respects and NEC Infrontia Ltd shall not be liable for any errors or omissions. In no event shall NEC Infrontia Ltd be liable for any incidental or consequential damages in connection with the use of this manual. This document contains proprietary information that is protected by copyright. All rights are reserved. No part of this document may be photocopied or reproduced without prior written consent of NEC Infrontia Ltd.

Copyright © 2004 by NEC Infrontia Ltd
All Rights Reserved.

www.neci.co.uk

Issue 1.6 August 2009
991405-5