

**Smart Communication Server**

# ***SL1100***

**Single-Line Telephone**

**User Guide**

**Please read this manual carefully before operating  
this product and save this manual for future use.**

# Before using Your Terminal...

Thank you for purchasing NEC SL1100 system.

Due to the flexibility built into the system, your **Dialing Codes and Feature Capacities** may differ from those in this guide. Check with your NEC Authorized Supplier / System Administrator and make a note of any differences.

NEC Single-Line Telephone (AT-45) is displayed here. This User Guide describes general analog Single-Line Telephone (SLT) procedures. Refer to the User Guide included with to your specific SLT for details on additional key functions.

**Hookflash**

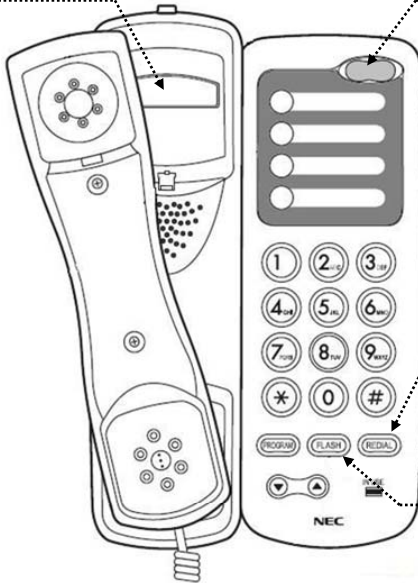

**INDICATOR**

Flashes when you have Message Waiting or there is an incoming call.

**REDIAL Key**

Press REDIAL Key to automatically redial the last number you dialed.

**FLASH (RECALL) Key**

While on a call, press FLASH Key to hold the line.

NEC Single-Line Telephone  
(AT-45)

NEC Corporation reserves the right to change the specifications, functions, or features at any time without notice. NEC Corporation has prepared this document for use by its employees and customers. The information contained herein is the property of NEC Corporation and shall not be reproduced without prior written approval of NEC Corporation.

Copyright 2011, NEC Corporation

Printed in Japan

# Placing Calls

## ■ Place an Outside Call <Quick Access>

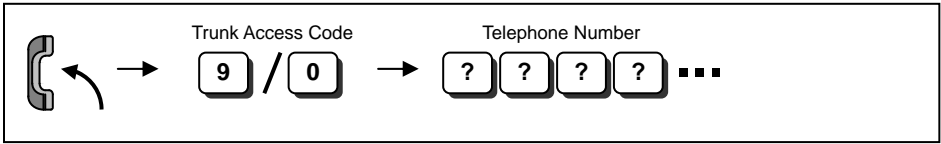

- To change the Trunk Access Code, Ask your NEC Authorized Supplier for the details.
- Listen to the Dial Tone before dialing a Telephone Number.

## ■ Place an Intercom Call <Dial Access>

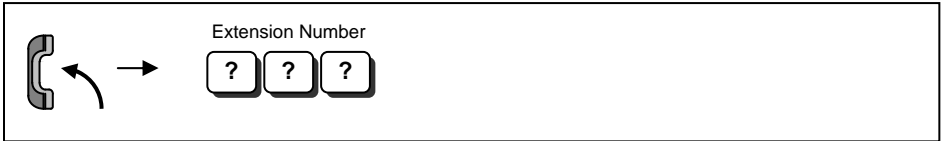

- Your call will ring or voice-announce. If you hear ringing, wait for an answer. If you hear a beep, begin speaking. Dialing "1" changes voice/ring mode. (in case the destination is Multi-line Terminal)

# Placing Calls Quickly

## ■ Abbreviated (Speed) Dialing <for Outside>

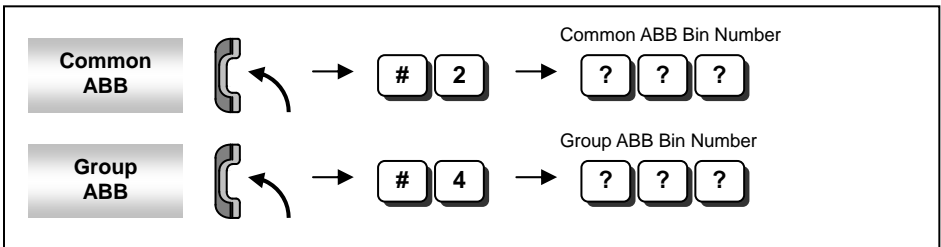

- The digit of Bin No. depends on the system setting. (0-9<Only Group ABB> / 00-99 / 000-999)
- Telephone Numbers shall be pre-registered to the system.
- System setting is necessary for Group ABB. Ask your NEC Authorized Supplier for the details.

## ■ Last Number Dialing <for Outside/Intercom>



# If your call doesn't go through...

## ■ Set Camp On / Callback

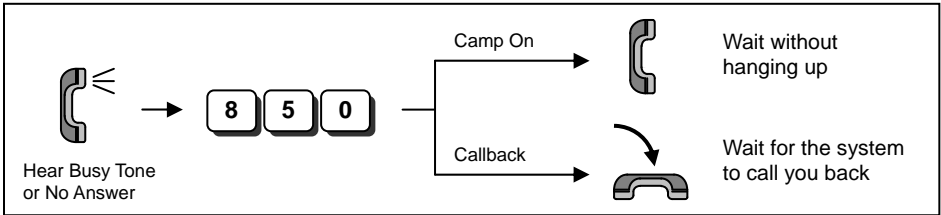

- **Camp On** In case of Intercom Call, when you hear ringing, wait for the called party to answer. In case of Outside Call, when you hear Dial Tone, begin telephone number dialing.
- **Callback** In case of Intercom Call, when your terminal starts the ringing, lift handset and wait for the called party to answer. In case of Outside Call, when your terminal starts the ringing, lift handset, hear Dial Tone, and begin telephone number dialing.
- This function is applicable in case all trunks are busy condition. (not applicable for dialed outside party busy)

## ■ Cancel Camp On / Callback

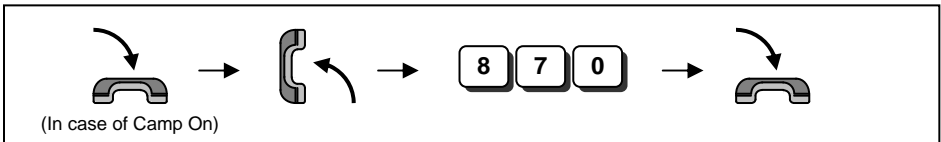

## ■ Set / Answer a Message Waiting

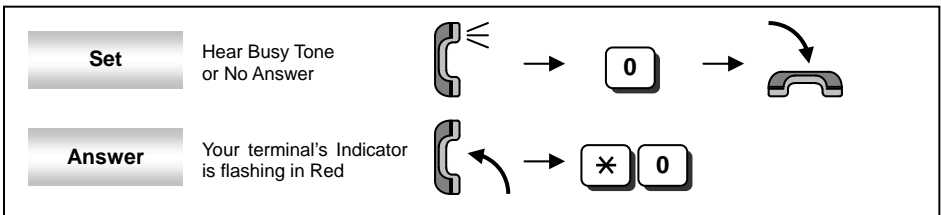

- When you set a MW, the called party's Indicator starts to flash.
- When you answer a MW, the Indicator shall automatically be off when the called party answers.

## ■ Cancel Message Waiting

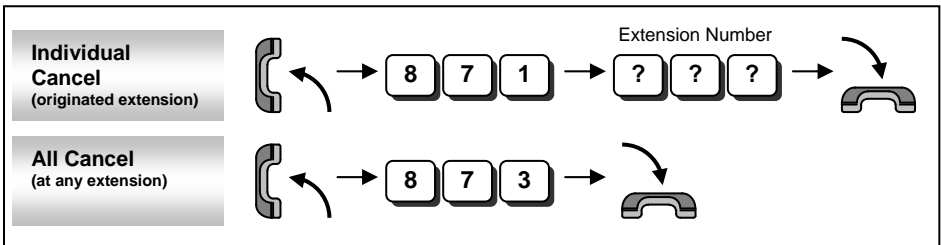

# Answering Calls

## ■ Answering an Outside Call / Intercom Call (at Ringing Extension)



## ■ Picking Up a Call for other Extensions

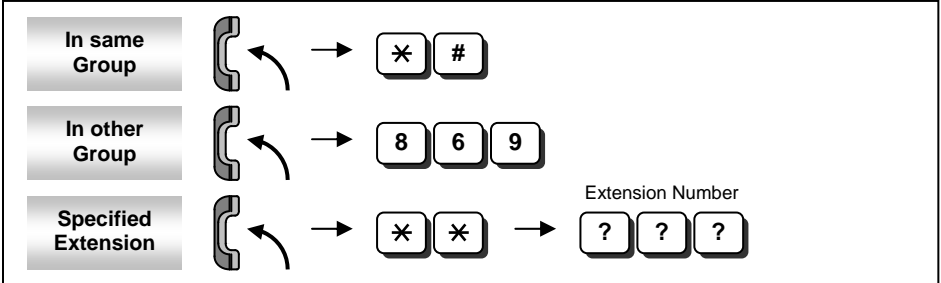

- System setting is necessary to make Call Pickup Group. Ask your NEC Authorized Supplier for the details.

# Hold / Transferring Calls

## ■ Holding a Call / Retrieving a Held Call

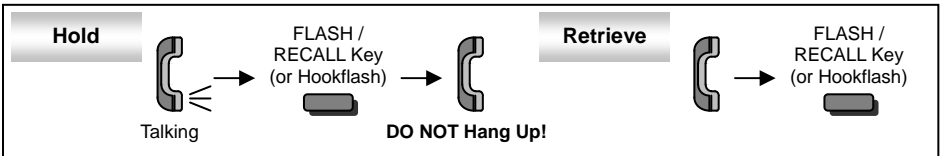

- If you go on hook, the held call will ring back.
- This operation puts your outside call on Exclusive Hold. Other extension user can not take the call off Hold.

## ■ Retrieve a Held Outside Call

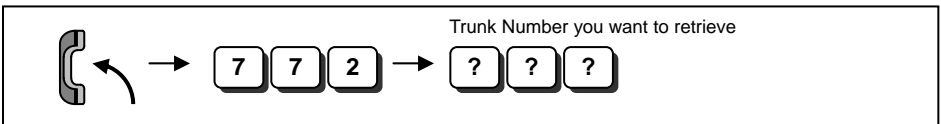

- For the dial digit of Trunk Number, ask your NEC Authorized Supplier for the details.

## ■ Transferring a Call to the other Extension

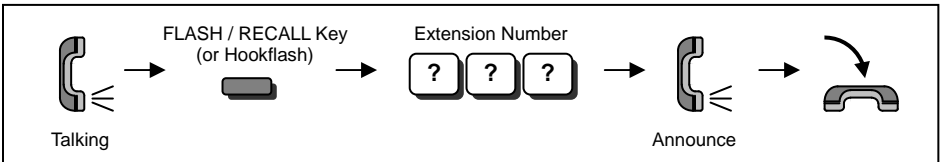

# For more Convenient Use...

## ■ Do Not Disturb (DND)

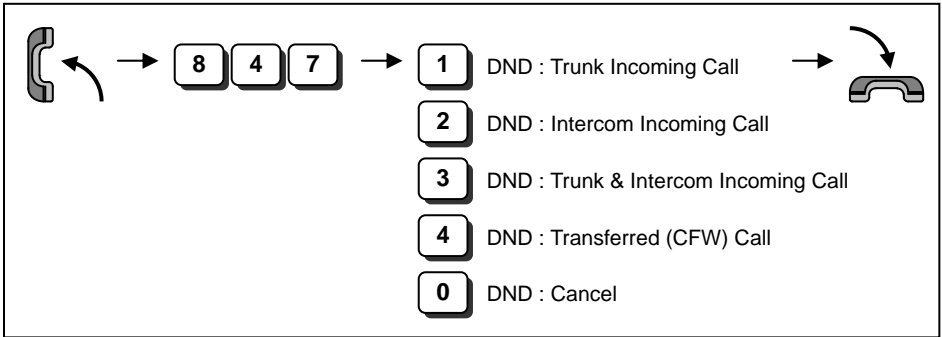

- When you set DND function, the Internal Dial Tone pattern shall be changed.

## ■ Conference

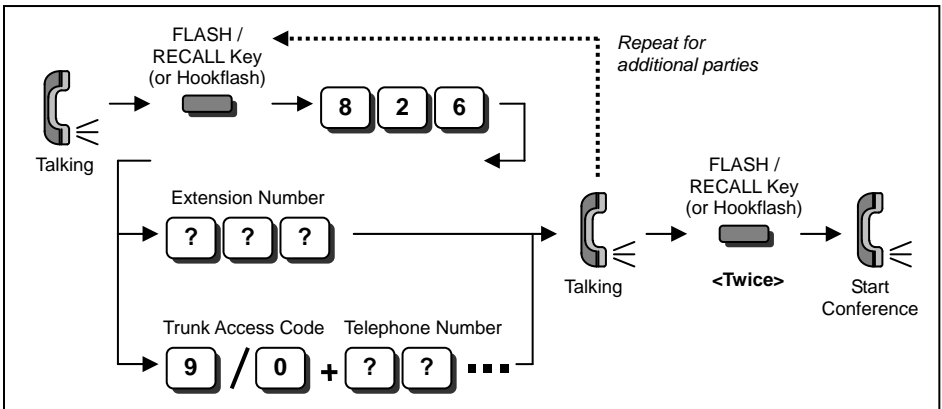

- You can repeat this operation to add more parties.
- You may be able to have up to 16 parties. (include your extension) May need to adjust the volume level due to the Environment where calls are placed. Ask your NEC Authorized Supplier for the details.

## ■ Call Forwarding / Follow Me

When you set Call Forward / Follow Me function, the Internal Dial Tone pattern shall be changed.

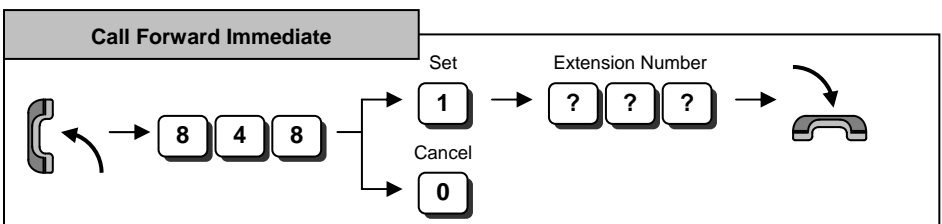

# For more Convenient Use...

## ■ Call Forwarding / Follow Me (Cont'd)

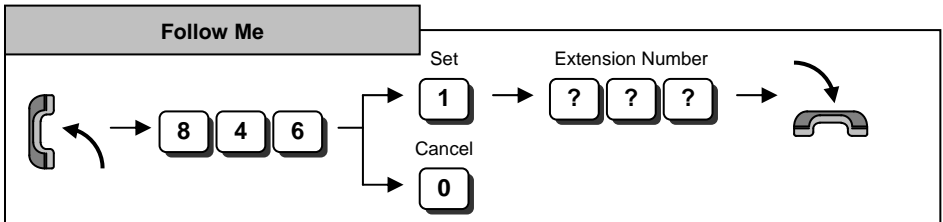
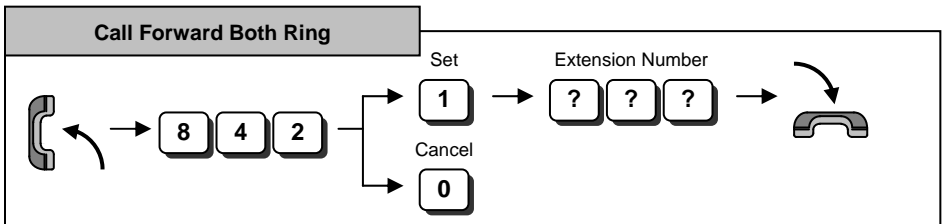
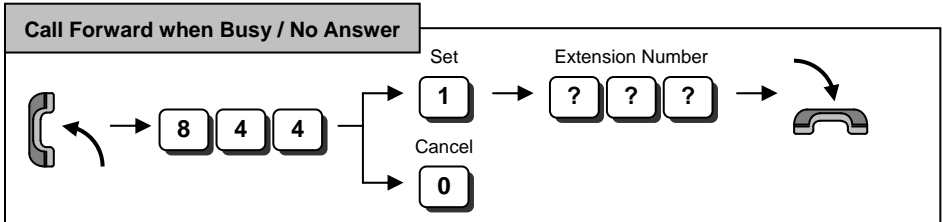
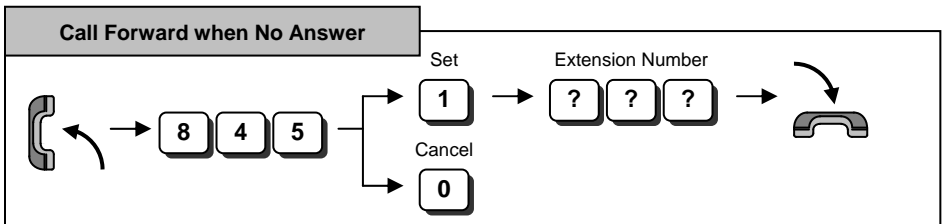
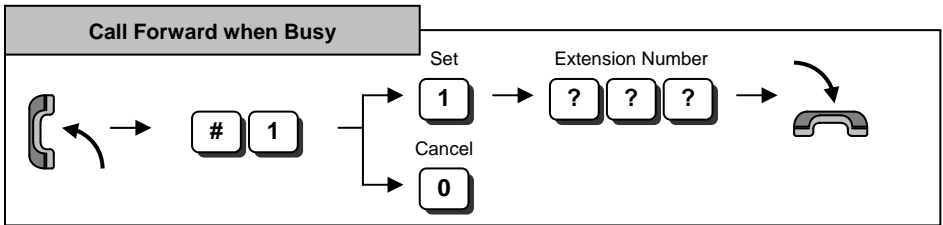

# Built-In Answering Machine (VRS Message)

System setting is necessary to use Built-In Answering Machine. Ask your NEC Authorized Supplier for the details.

## ■ Record / Listen / Erase Answering Messages

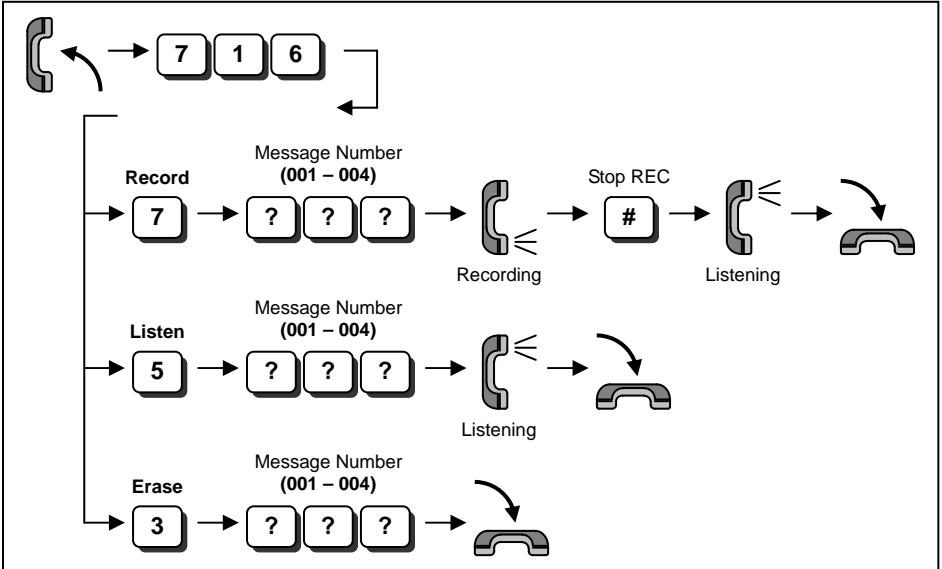

- Up to 4 types of messages can be recorded.
- The Message length can not exceed 2 minutes.

# Built-In Answering Machine (Voice Mail Message)

## ■ Listen / Erase Left Messages

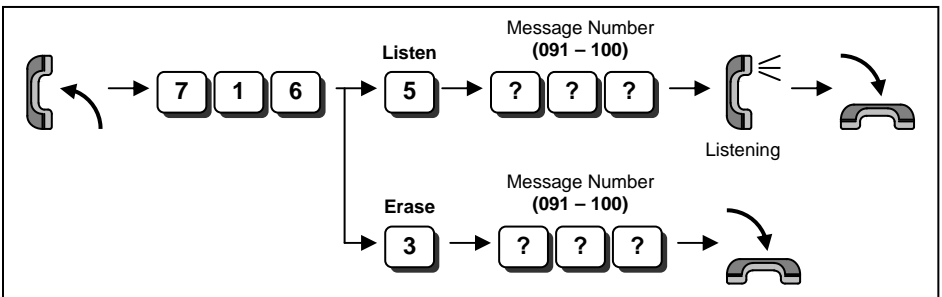

- Up to 10 messages can be left from outside.
- The Message length can not exceed 2 minutes.



# Option : In-Mail (Voice Mail)

*Optional hardware and System setting is necessary to use In-Mail (Voice Mail) feature. Ask your NEC Authorized Supplier for the details.*

## ■ Log-On to the In-Mail

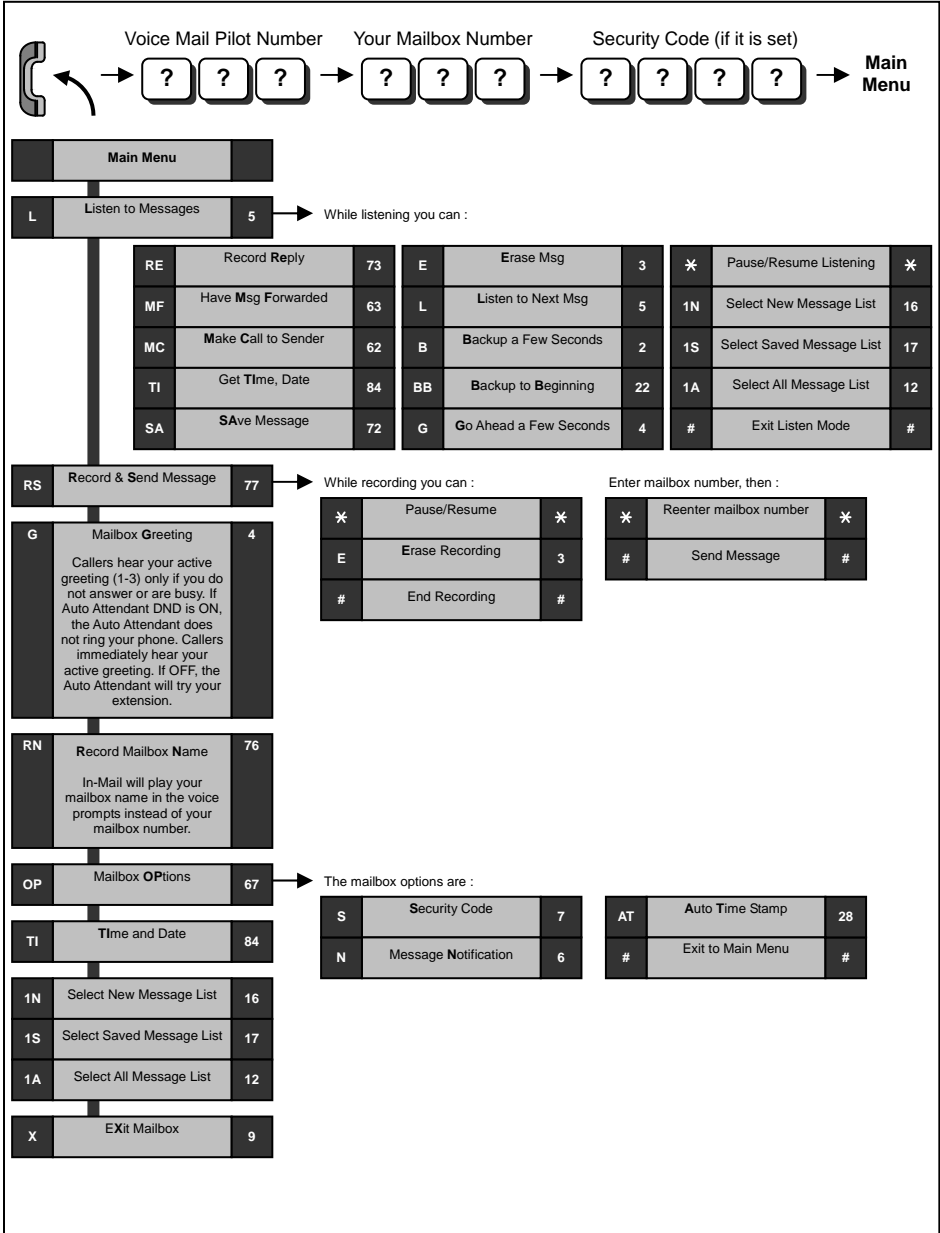

# Option : In-Mail (Voice Mail)

## ■ Call Forward to Voice Mail

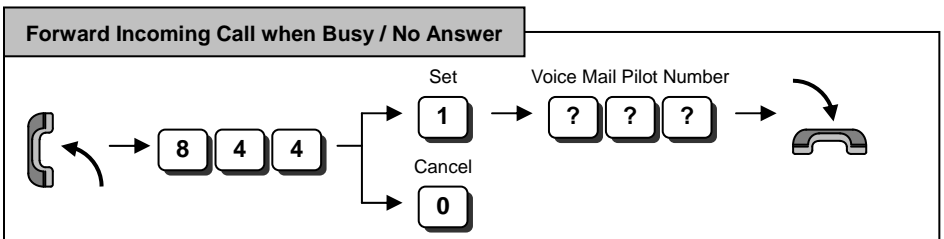
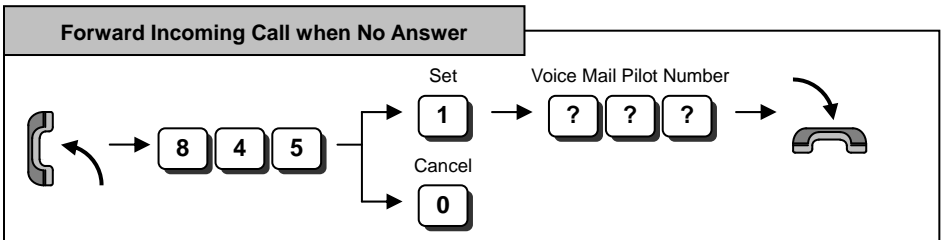
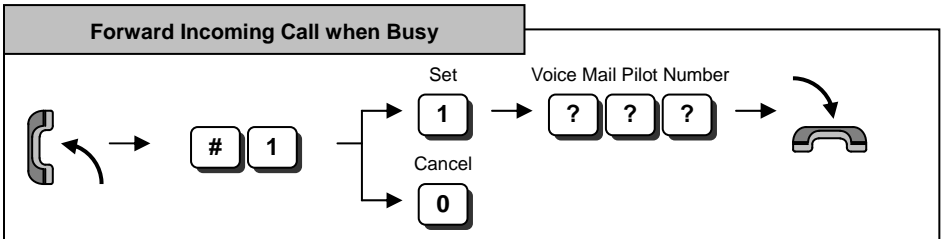
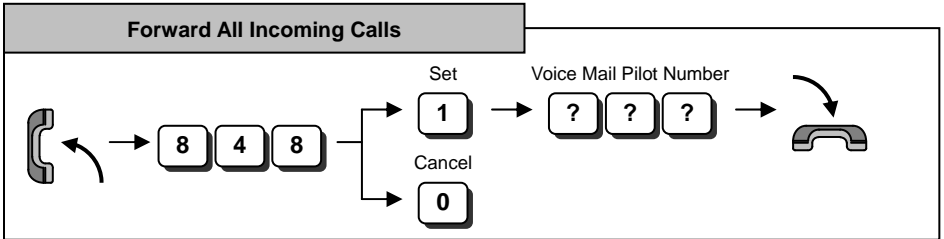

# Option : In-Mail (Voice Mail)

## ■ Mailbox Greeting

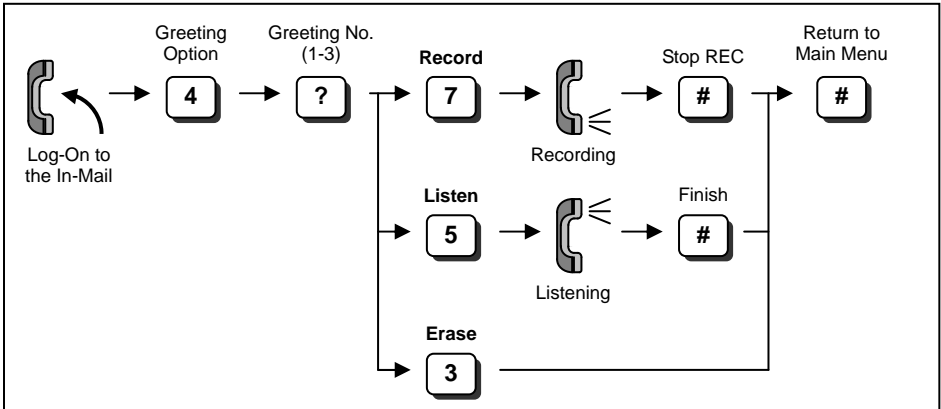

- Selected Greeting (one of three) shall be made active.

## ■ Mailbox Security Code

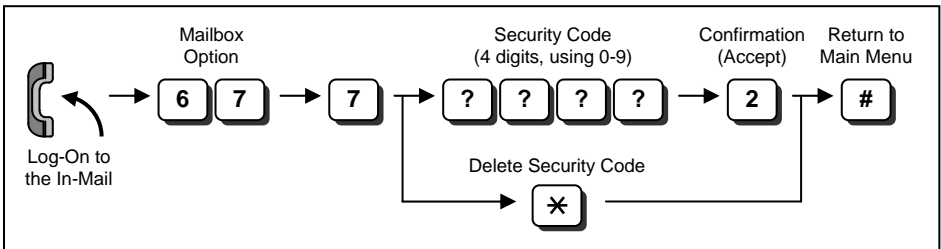

- Dialed Security Code can be canceled by pressing "4" instead of "2 (Accept)".
- In case the "In-Mail Advanced Features License (SL-VM-ADVANCE LIC)" is provided, or during Free Trial period (60 days after new installation), the type of Security Code can be assigned as below.
  - Dial 4 digits Security Code followed by "7": Security Code for all log-on
  - Dial 4 digits Security Code followed by "6": Security Code for remote log-on only
- System Administrator can delete a Mailbox Security Code.

## ■ Listen to Left Messages in your Mailbox

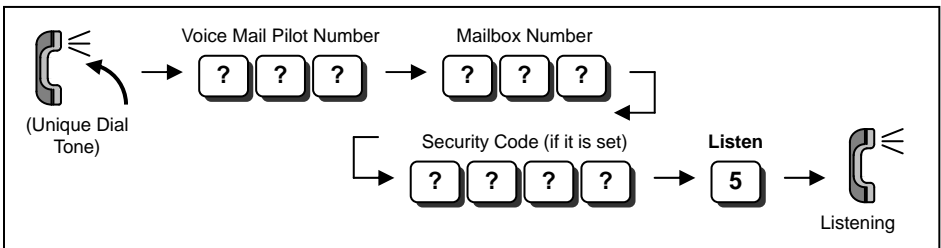

A50-031930-001  
Issue 1.0  
May 2011

# ***SL1100***

Single-Line Telephone  
User Guide

**NEC Corporation**